

1.4.2.3 Standard Customized Solutions (OEM) Thermal Sensors

10mW to 20W

Features

- Conduction cooled
- Thermal sensors are spectrally flat
- Analog, RS232, USB compatible and Ethernet output

20C-BB-12-SH



20C-UAS



20C-UAU



20C-UAU / 20C-UAE



These specifications refer to standard OEM sensors, and are to be understood as generic, describing sensor families. Ophir will be happy to help you with a specific solution for your particular application.

Model	20C-BB-12-SH	20C-UAS	20C-UAU / 20C-UAE
Type	Smart sensor	RS232 or Analog output	UAU – USB compatible output UAE – Ethernet output
Features	Compact smart sensor	Small size, built in amplifier	Small size, external amplifier
Absorber Type	Broadband	Broadband	Broadband
Spectral Range μm	0.19 - 11	0.19 - 11 ^(c)	0.19 - 11 ^(c)
Absorption	~88%	~88%	~88%
Aperture mm	\varnothing 12	\varnothing 12	\varnothing 12
Power Mode			
Maximum power ^(a) free standing	4W continuous, 20W for 1.8 min	4W continuous, 20W for 1.8 min	4W continuous, 20W for 1.8 min
heat sinked	20W	20W	20W
Minimum power	10mW	10mW	10mW
Power Noise Level	0.2mW	0.2mW	0.2mW
Maximum Average Power Density kW/cm ²	23 at 20W 35 at 4W	23 at 20W 35 at 4W	23 at 20W 35 at 4W
Response Time (0-95%), typ. (sec)	0.8	0.8	0.8
Calibration Uncertainty $\pm\%$	1.9	1.9	1.9
Power Accuracy $\pm\%$ at calibrated wavelength	3 ^(d)	3 ^(d)	3 ^(d)
Linearity with Power $\pm\%$	1	1	1
Amplifier power supply	NA	+6V to +24V	UAU - Via Host USB UAE +6V to +24V
Energy Mode			
Maximum Energy	10J	10J	10J
Minimum Energy	6mJ	6mJ	6mJ
Energy Accuracy $\pm\%$ at calibrated wavelength	5	5	5
Maximum Energy Density J/cm ²			
<100ns	0.3	0.3	0.3
0.5ms	2	2	2
2ms	2	2	2
10ms	2	2	2
Cooling	Conduction	Conduction	Conduction
Connections	Ophir smart plug	6 pin Molex ^(b)	UAU - Mini B USB connector UAE - Ethernet for communication M12 5 pin for power
Dimensions	38x38x14mm	38x38x34mm	38x38x14mm
Compliance	CE, UKCA, China RoHS	RoHS, China RoHS	RoHS, China RoHS
Version	V1		
Part number	7Z07129	Consult Ophir Representative	Consult Ophir Representative

Note: (a) With analog "UA/UAS" version, maximum power is also limited by maximum output voltage where output voltage is at most 2V less than input voltage

Note: (b) 6 pin Molex connections: RS232 input, Ground, +Voltage, Analog signal out, high/low voltage or switch input when used, RS232 output

Note: (c) Calibrated at customer selected wavelength

Note: (d) \pm 4%. For wavelengths <240nm

* For drawings please see page 152

* For UAE & UAU drawings please see pages 161-162

20C-BB-12-SH

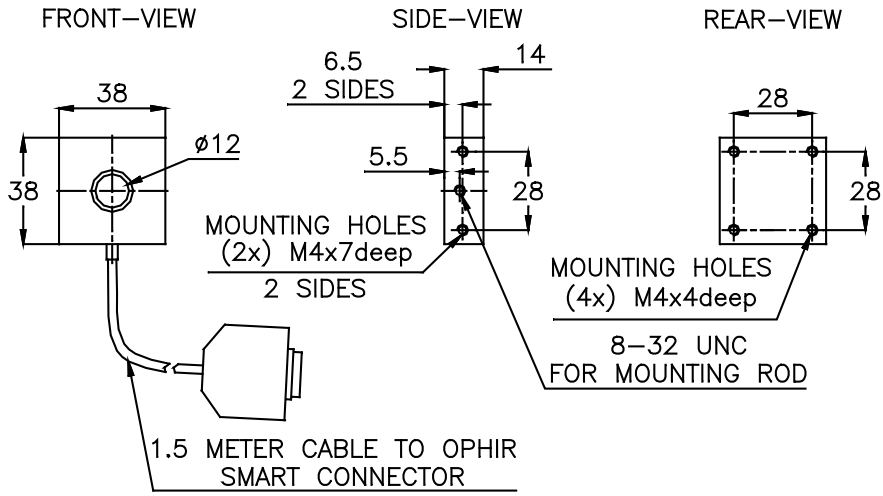

20C-UAS

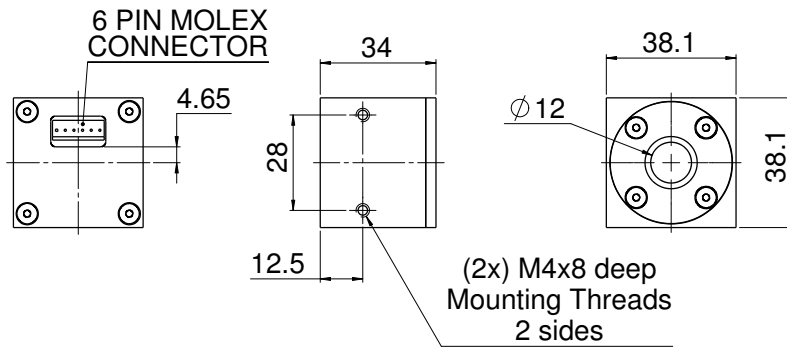

UAE Drawings

20C-UAE

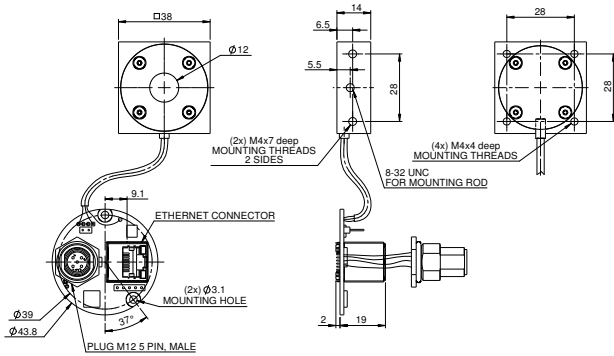

L30C-UAE

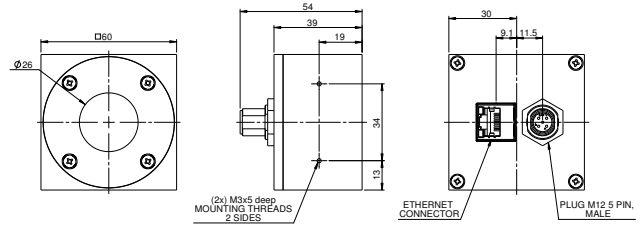

100C-UAE

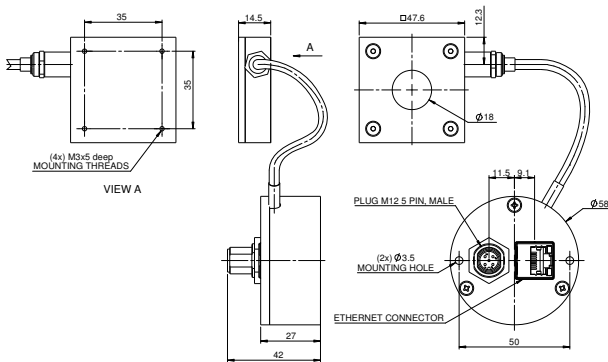

150C-UAE

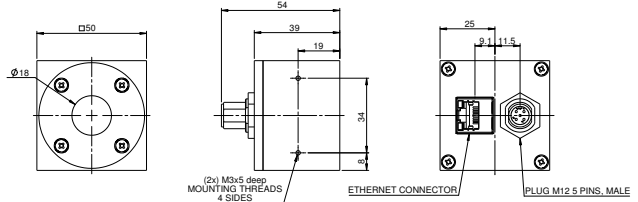

150W-UAE

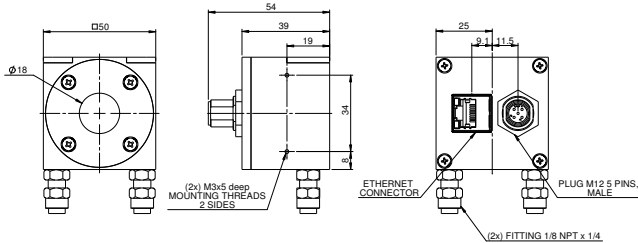

L150C-UAE

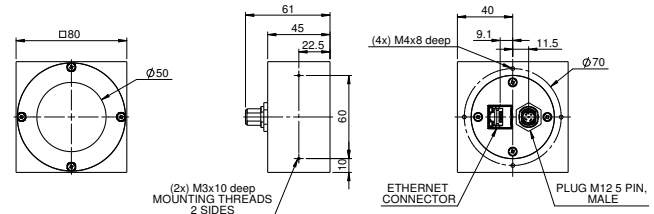

L250W-UAE / L300W-UAE

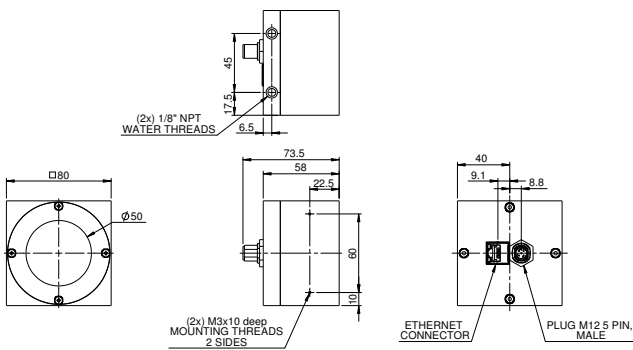

600W-UAE

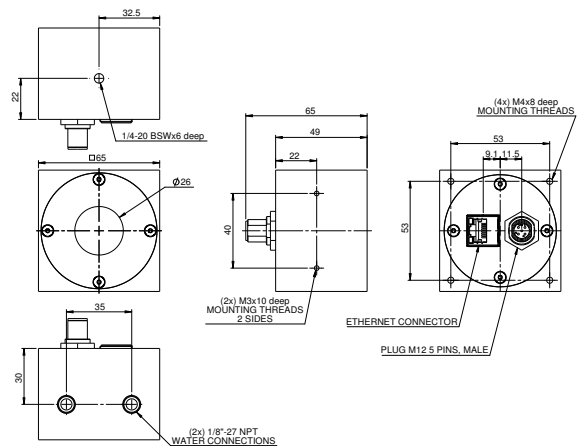

UAU Drawings

20C-UAU

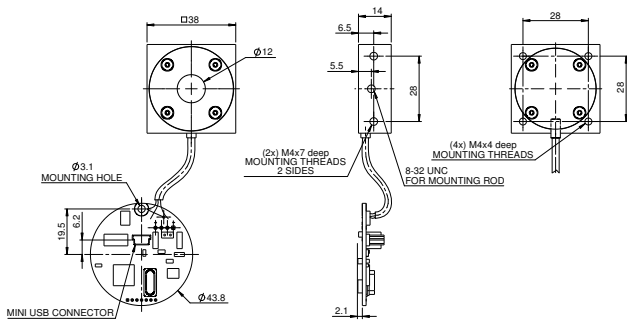

L30C-UAU

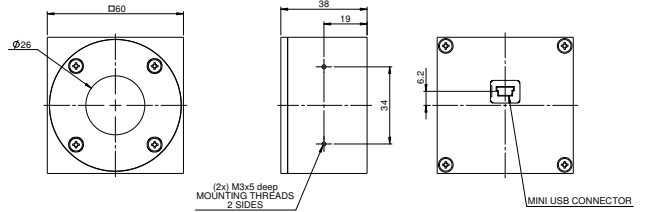

100C-UAU

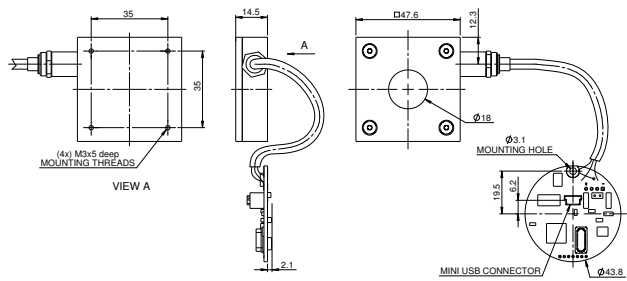

150C-UAU

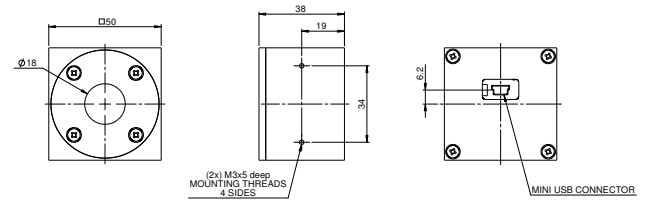

150W-UAU

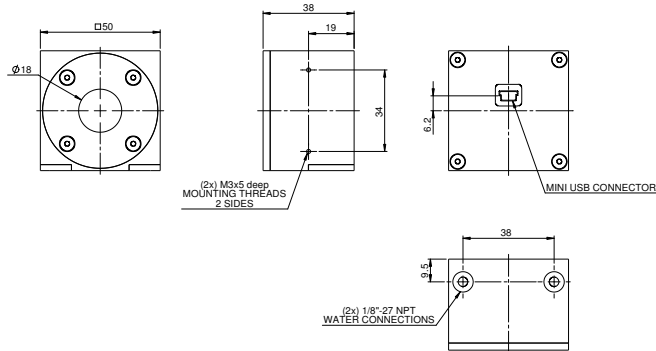

L150C-UAU

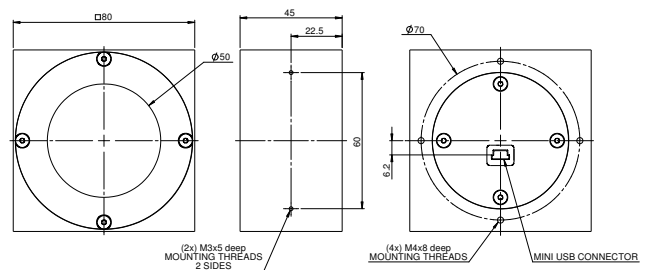

L250W-UAU / L300W-UAU

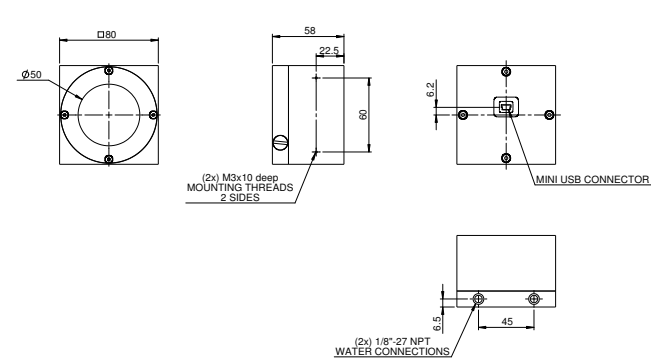

600W-UAU

