

1.1.2.5 Medium Power Large Aperture Thermal Sensors - Apertures to 65mm

300mW to 300W

Features

- Thin profile, very large aperture
- CW to 50W, intermittent to 300W
- Ø50mm to Ø65mm apertures

For L50(250)A-BB-50:

- Pulse energies up to 4,000 Joules
- Measure high power lasers by 0.5-4s exposures

L50(250)A-BB-50



L50(300)A-LP2-65

L50(300)A-BB-65 /
L50(300)A-PF-65

Model	L50(250)A-BB-50	L50(300)A-BB-65	L50(300)A-LP2-65	L50(300)A-PF-65
Use	General purpose	General purpose	Long pulse lasers	Large beam short pulsed lasers
Absorber Type	Broadband	Broadband	LP2	PF type
Spectral Range μm	0.19 - 11	0.19 - 11	0.25 - 2.2	0.15 - 20
Absorption	~88%	~88%	>94% from 0.25 to 1.1 μm	~85%
Aperture mm	Ø50mm	Ø65mm	Ø65mm	Ø65mm
Power Mode				
Power Range	300mW - 250W ^(a)	400mW - 300W	400mW - 300W	400mW - 300W
Maximum Intermittent Power	250W for 1.5min, 150W for 3min, 80W for 6min, 50W continuous ^(a)	300W for 2min, 150W for 4.5min, 50W continuous		
Power Scales	250W / 30W	300W / 30W	300W / 30W	300W / 30W
Power Noise Level	15mW	20mW	20mW	20mW
Maximum Average Power Density kW/cm ²	10 at 250W 17 at 50W	9.5 at 300W 17 at 50W	17 at 300W 50 at 50W	3
Response Time with Meter (0-95%) typ. s	2.5	3	3	3
Calibration Uncertainty $\pm\%$	1.9	1.9	1.9	1.9
Power Accuracy $\pm\%$	3 ^(g)	3 ^(g)	3 ^(g)	4 ^(c)
Linearity with Power $\pm\%$	1	1	1	1
Beam Size Dependence	<1% for beams up to 35mm diameter	NA	NA	NA
Energy Mode				
Energy Range	100mJ - 4000J	200mJ - 300J	200mJ - 1000J	200mJ - 300J
Energy Scales	4kJ / 400J / 40J / 4J	300J / 60J / 6J	1000J / 600J / 60J / 6J	300J / 60J / 6J
Minimum Energy mJ	100	200	200	200
Maximum Energy Density J/cm ²				Single ^(d) 10-50Hz ^(d)
<100ns	0.3	0.3	0.1	3 ^(e) 1.5
1 μs	0.4	0.4	0.9	3 ^(e) 1.5
0.5ms	5	5	50	7 7
2ms	10	10	130	15 15
10ms	30	30	400	40 40
>300ms	See below ^{(a), (f)}	NA	NA	NA
Cooling	convection	convection	convection	convection
Fiber Adapters Available (see page 120)	ST, FC, SMA, SC	NA	NA	NA
Weight kg	0.6	0.9	0.9	0.9
Compliance	CE, UKCA, China RoHS	CE, UKCA, China RoHS	CE, UKCA, China RoHS	CE, UKCA, China RoHS
Version	V1	V1		
Part number	7Z07109	7Z07127	7Z02782	7Z02743

Note: (a) Long pulses (0.5 – 4s) can be used to measure power of high power lasers by measuring the energy of a short exposure. The StarBright, Juno, Juno+, Juno-RS and Centauri meters have a Pulsed Power mode where the user may specify the pulse width and get a reading directly in units of power for this short exposure energy measurement. See also page 108

Note: (b) Above 1.1 μm there is an additional calibration uncertainty of up to 2%

Note: (c) Calibrated for 0.25 – 2 μm , 10.6 μm

Note: (d) For 10-50Hz, derate as follows:

Wavelength	Derate to value
1064nm	Not derated
532nm	Not derated
355nm	70% of stated value
266nm	15% of stated value
193nm	10% of stated value

Note: (e) Damage threshold 1.5J/cm² for wavelengths <500nm

Note: (f) Recommended exposure times and 1/e ² Gaussian beam diameters for very long pulses. Total energy for a series of measurements should not exceed 20kJ. Cooling down time before another 20kJ series, 10min. Recommended time between shots 12s.	Laser Power W	Recommended Exposure s	Number of shots before cooling down	Min 1/e ² beam dia. mm
	500	2	20	14
	1000	1	20	14
	2000	1	10	21
	4000	1	5	32
	5000	1	4	NA
	10000	0.3	4	NA

Note: (g) $\pm 4\%$. For wavelengths <240nm

* For drawings please see page 69

L50(250)A-BB-50

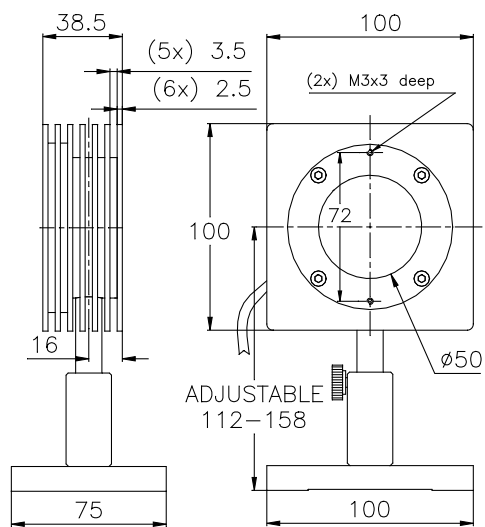

L50(300)A-BB-65 / L50(300)A-LP2-65 / L50(300)A-PF-65

