

## 1.4.2.3 Standard Customized Solutions (OEM) Thermal Sensors

### 0.2W to 600W

#### Features

- Conduction and water cooled
- Spectrally flat
- UAF version can give analog voltage output or digital RS232 output and can measure power or energy. Can also have multiple switchable ranges and/or multiple switchable wavelengths
- UAU and UAE versions are similar to the UAF version but UAU operates via the USB terminal of the PC and UAE via an Ethernet connection

L150C-UAF / UAU / UAE



L250W-UAF / UAU / UAE  
L300W-UAF / UAU / UAE



600W-UAF / UAU / UAE



These specifications refer to standard OEM sensors, and are to be understood as generic, describing sensor families. Ophir will be happy to help you with a specific solution for your particular application.

Model	L150C-UAF	L250W-UAF / L300W-UAF	600W-UAF	UAU / UAE versions
Type	RS232 or Analog output	RS232 or Analog output	RS232 or Analog output	Same as UAF but with: UAU – USB compatible output UAE – Ethernet output
Features	Large aperture, built-in amplifier	Large aperture, built-in amplifier, water cooled	High power, built-in amplifier, water cooled	
Absorber Type	Broadband	Broadband	LP2	
Spectral Range $\mu\text{m}$	0.19 - 20 <sup>(c)</sup>	0.19 - 20 <sup>(c)</sup>	0.35 - 2.2	
Absorption	~88%	~88%	>94% from 0.35 to 1.1 $\mu\text{m}$	
Aperture mm	$\varnothing$ 50	$\varnothing$ 50	$\varnothing$ 26	
Power Mode				
Maximum power <sup>(a)</sup> free standing	20W for 3 minutes	250W / 300W water cooled	600W water cooled	
heat sinked	150W	60W	NA	
Minimum power	0.2W	0.3W / 0.5W	5W	
Power Noise Level	10mW	15mW / 25mW	200mW	
Maximum Average Power Density kW/cm <sup>2</sup>	27 at 20W 12 at 150W	10 / 9 at max power	11 at max power	
Response Time (0-95%), typ. (sec)	2.5	2.5	2.5	
Calibration Uncertainty $\pm\%$	1.9	1.9	1.9	
Power Accuracy $\pm\%$ at calibration wavelength	3	3	3	
Linearity with Power $\pm\%$	1	2	2	
Amplifier power supply	+6V to +24V	+6V to +24V	+6V to +24V	UAU - Via Host USB UAE +6V to +24V
Energy Mode				
Maximum Energy	100J	200J / 300J	300J	
Minimum Energy	80mJ	120mJ / 200mJ	500mJ	
Energy Accuracy $\pm\%$ at calibrated wavelength	5	5	5	
Maximum Energy Density J/cm <sup>2</sup>				
<100ns	0.3	0.3	0.1	
0.5ms	5	5	50	
2ms	10	10	130	
10ms	30	30	400	
Cooling	Conduction	Water	Water	
Minimum and Recommended water flow at full power <sup>(d)</sup>	NA	3 liter/min	3 liter/min 4.5 liter/min	
Connections	6 pin Molex <sup>(b)</sup>	5 pin Round connector	6 pin Molex <sup>(b)</sup>	UAU - Mini B USB connector UAE - Ethernet for communication M12 5 pin for power
Dimensions	80x80x45mm	80x80x58mm	65x65x49mm	
Compliance	RoHS, China RoHS	RoHS, China RoHS	RoHS, China RoHS	RoHS, China RoHS
Part number	Consult Ophir Representative	Consult Ophir Representative	Consult Ophir Representative	Consult Ophir Representative

Note: (a) With analog "UAF" versions, sensor voltage output is accurate up to 2v below lowest level of supply voltage, taking into account supply voltage ripple

Note: (b) 6 pin Molex connections: RS232 input, Ground, +Voltage, Analog signal out, high/low voltage or switch input when used, RS232 output

Note: (c) Calibrated at customer selected wavelength

Note: (d) Water temperature range 18-30°C. Water temperature rate of change <1°C/min. Pressure drop across sensor 0.03MPa. The recommended flow rate can be lowered proportionately at lower than full power but should not be below the minimum. When used at full power with substantially below the recommended flow rate, the damage threshold may be as much as 20% lower and the response time may not be optimum

\* For drawings please see page 160

\* For UAE & UAU drawings please see pages 161-162

L150C-UAF

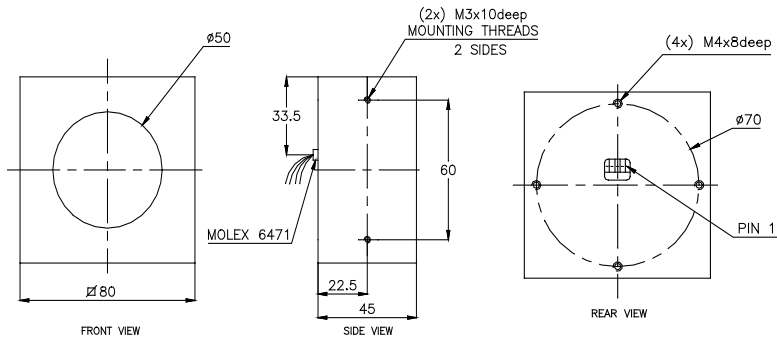

L250W-UAF / L300W-UAF

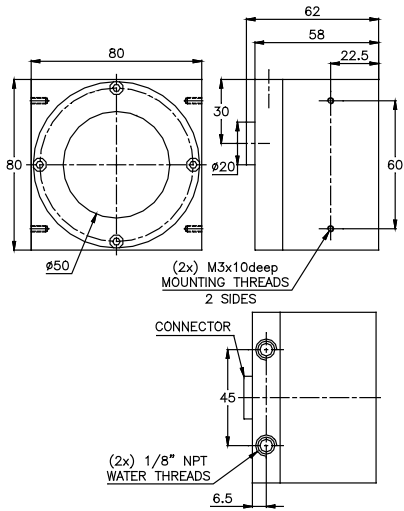

600W-UAF

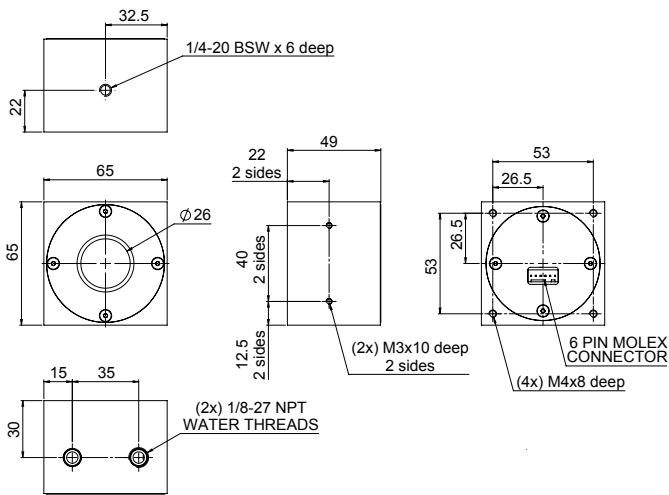

# UAE Drawings

20C-UAE

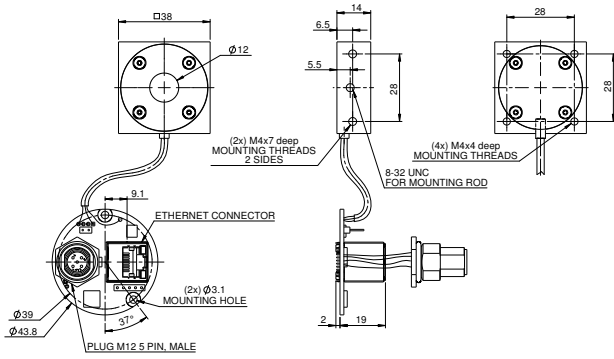

L30C-UAE

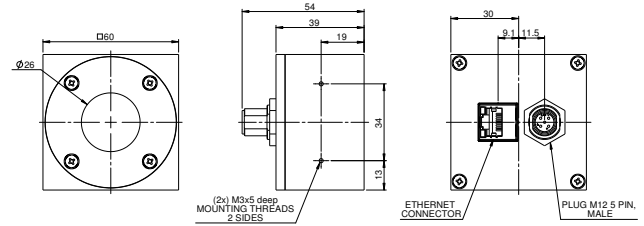

100C-UAE

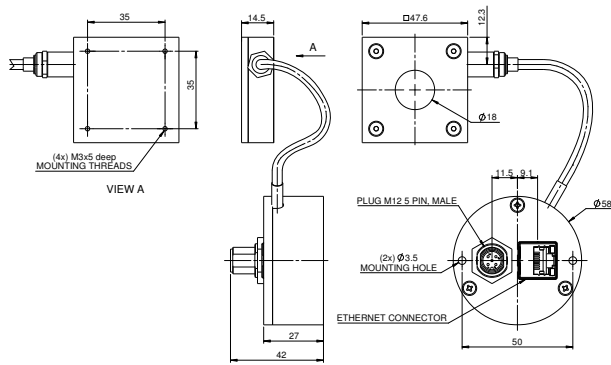

150C-UAE

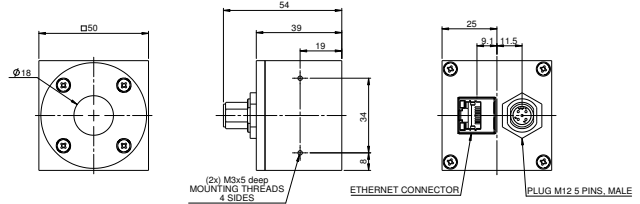

150W-UAE

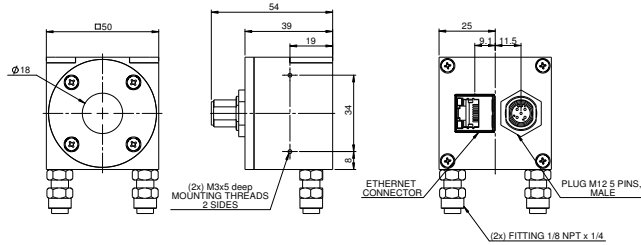

L150C-UAE

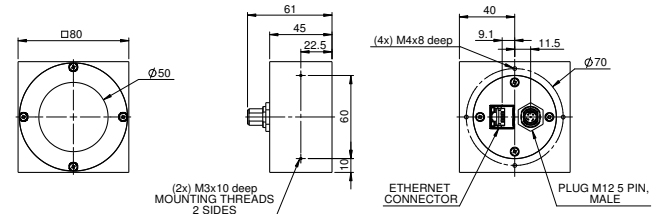

L250W-UAE / L300W-UAE

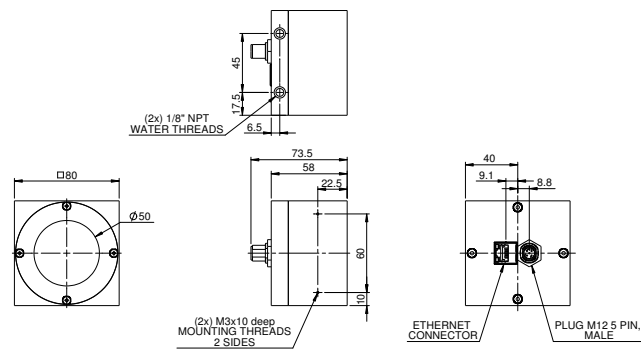

600W-UAE

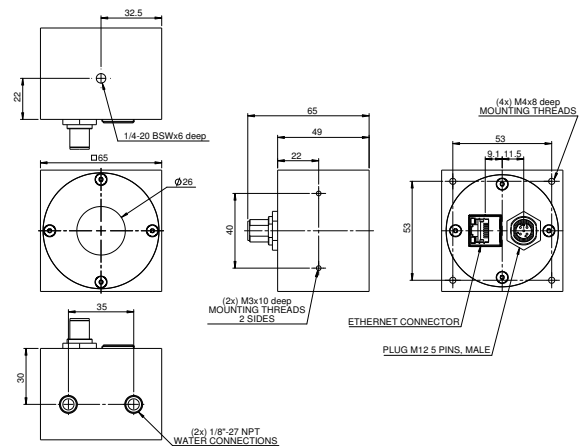

# UAU Drawings

20C-UAU

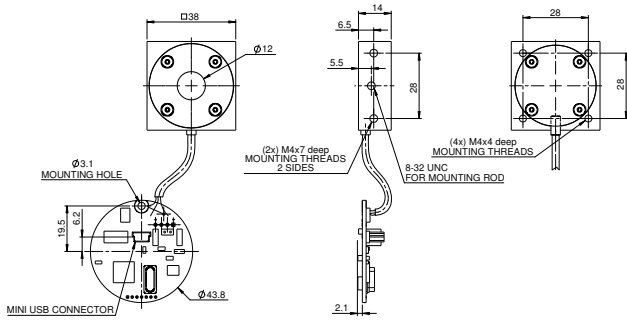

L30C-UAU

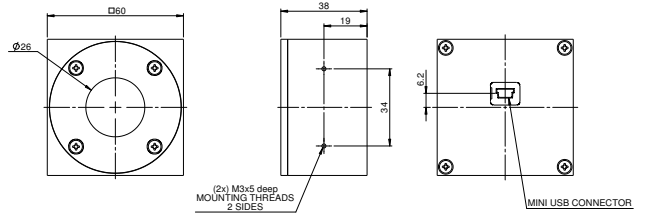

100C-UAU

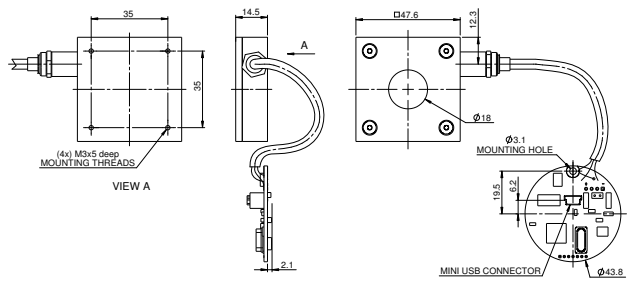

150C-UAU

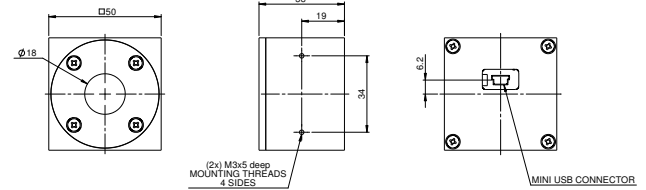

150W-UAU

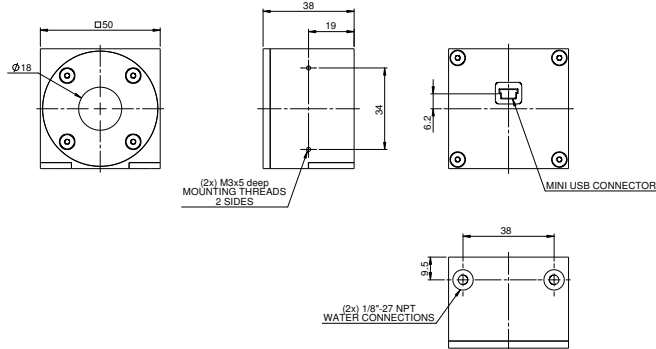

L150C-UAU

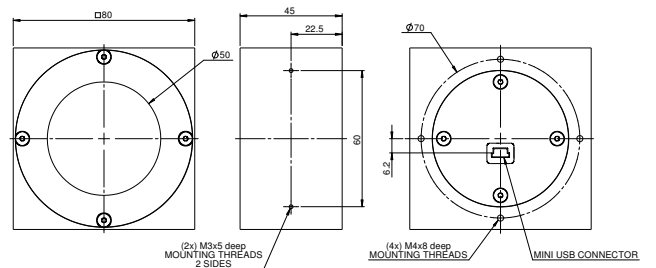

L250W-UAU / L300W-UAU

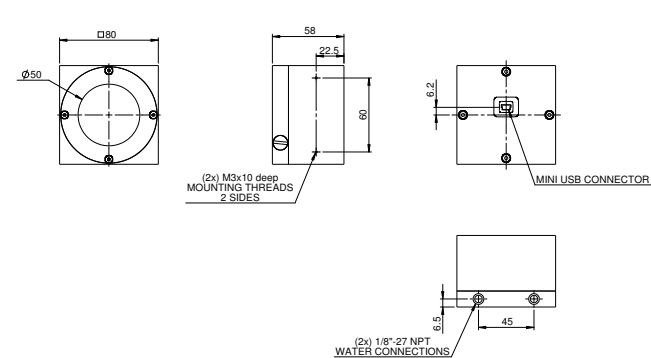

600W-UAU

