

1.1.4 Accessories for Thermal Sensors

1.1.4.1 Fiberoptic Adapters

Sensor Series	Fiber adapter mounting bracket (1 bracket fits all fiber adapters)	SC fiber adapter	ST fiber adapter	FC, FC/APC fiber adapter	SMA fiber adapter
Thermal Sensors					
2A-BB-9 / 3A / 3A-QUAD / 3A-P / 3A-P-QUAD / 3A-PF-12 / 3A-FS / 3A-P-THz	not needed				
10A / 10A-BB-16-PPS / 10A-P	not needed				
12A / 12A-P	not needed				
30A-BB-18 / 30A-N-18 / 30(150)A-BB-18 / 30(150)A-LP2-18 / F50A-BB-18	7Z08211				
50(150)A-BB-26 / 50(150)A-BB-26-PPS / 50(150)A-BB-26-QUAD / F150A-BB-26 / F150A-BB-26-PPS	7Z08210	7Z08227	7Z08226	7Z08229	1G01236A
L50(150)A-BB-35 / L50(150)A-LP2-35 / L50(150)A-PF-35 / FL250A-BB-35 / FL250A-LP2-35	7Z08265				
30A-P-17 / 30(150)A-SV-17 / 30(150)A-HE-17	7Z08230				
L40(250)A-BB-50 / L40(250)A-LP2-50 / L50(250)A-BB-50	7Z08238 ^(a)				
FL250A-BB-50 / FL250A-BB-50-PPS / FL400A-BB-50 / FL400A-LP2-50	7Z08212				
L100(500)A-PF-120 / FL600A-BB-65 / FL600A-LP2-65 / 1000WP-BB-34 / 1000W-BB-34 / 1000W-BB-34-QUAD / 1000W-LP2-34 / FL1100A-BB-65 / FL1100A-LP2-65 / L1500W-BB-50 / L1500W-LP2-50 / L2000W-BB-120 / L2000W-PF-120 / 5000W-BB-50 / 5000W-LP2-50 / 5000WP-LP2-50	Threaded holes exist	Consult Ophir representative			

Note: (a) The fiber mounting bracket for these sensors is a triple adapter for mounting up to three different fibers looking at same spot

SC fiber adapter

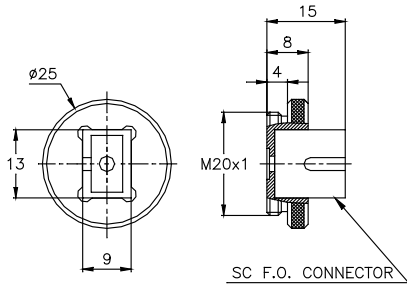

ST fiber adapter

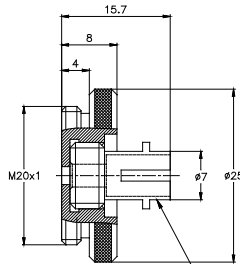

FC fiber adapter

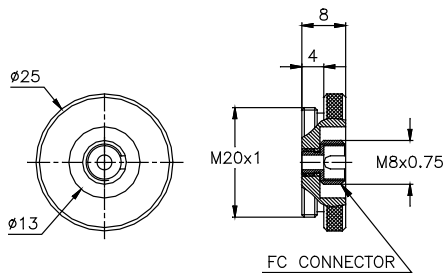

SMA fiber adapter

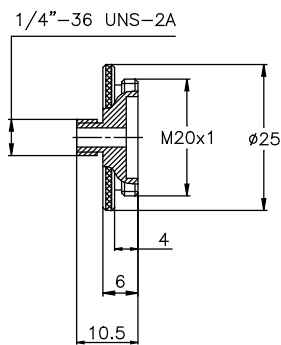

30A with F.O. input

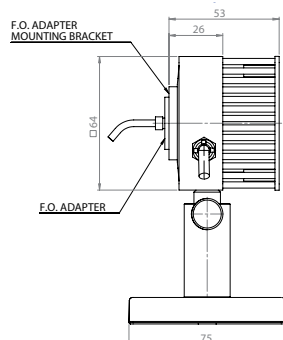

FL250A with F.O. input

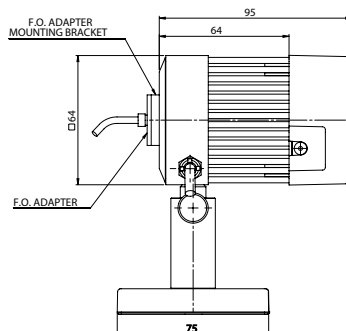

SC fiber adapter



ST fiber adapter



FC fiber adapter



SMA fiber adapter



1.1.4.2 Other Accessories

Accessories for High Power Sensors	Description	P/N	Ref
High Power QBH-Fiber Adapters for L1500W-LP2-50, L1500W-BB-50, 5000W-LP2-50 and 5000W-BB-50 Sensors	QBH-Fiber Adapters for mounting fibers with QBH termination to Ophir power sensors	7Z08348 (QBH-L-Fiber Adapter model) 7Z08349 (QBH-S-Fiber Adapter model)	See page 97
Protective Housing for 5000W, 10K-W and 15K-W Sensors	Protective Housing with shutter to protect from debris	7Z08344 (for 5000W / 10K-W / 15K-W)	See page 98
Scatter Shield for 10K-W, 15K-W, 16K-W and 30K-W Sensors	Scatter Shield to reduce backscattered power (including protective cover)	7Z08295 (for 10K-W / 15K-W) 7Z08355 (for 16K-W) 7Z08293 (for 30K-W)	See page 99
Protective Covers for Scatter Shields with Target Pattern for 10K-W, 15K-W and 30K-W sensors	Protective Covers for Ophir scatter shields. The cover has a target pattern for directing the beam using a pointer	7Z08345 (for 10K-W / 15K-W) 7Z08346 (for 30K-W)	See page 100
Protective Covers with Target Pattern for 1000W, L1500W, 5000W, 10K-W, 15K-W, 16K-W and 30K-W Sensors	Black anodized aluminum cover with a target pattern for directing the beam using a pointer	1G01332 (all except 16K-W & 30K-W) 1G02813 (for 16K-W) 1G02406 (for 30K-W)	See page 100
Metric Water Connectors for Water Cooled Sensors	Metric Water Connectors are quick connect fittings for 3/8" and 1/2" plastic tubing (set of 2 ea.)	7Z08353 (all except 16K-W & 30K-W) 7Z08352 (for 16K-W & 30K-W)	See page 100
Heavy Duty Stand for 10K-W and 15K-W	For continuous use in vertical position, heavy duty stand is recommended	7Z08330	See page 99
30K-W Rubber Feet Assembly	The rubber feet make it possible to lean the sensor on its rear side for better stability when used with a vertical beam. The kit has 4 feet which can be screwed into the existing threads	7Z08217	See page 99
General Accessories			
SH to BNC Adapter	Allows connection of sensor to current or voltage measuring device for measurement of raw sensor output. Current meter should be used for photodiode sensors. Current or voltage meter can be used for thermal sensors	7Z11010	
Replacement Parts			
	Application	P/N	
N Polarity Power Supply/Charger 12V 2A N-2.1x5.5	For: Centauri, Vega, Nova II, Nova, EA-1, Pulsar, Quasar, LaserStar, 120K-W, 6K-W, Fan Cooled Sensors	7E05029	
P Polarity Power Supply/Charger 12V 2A P-1.35x3.5	For: StarLite, StarBright, RM9 Chopper	7E05047	
Push-Pull 2 Pin Power Supply 12V 2A	For: IS1.5-VIS-FPD-800, IS1.5-IRG-FPD-800	7E05047A	

Protective Housing



7Z08352 1/4" - 12mm

30K-W Scatter Shield



7Z08353 1/8" - 10mm

Protective Cover on Scatter Shield



10K-W with 34-50mm Aperture Protective Cover



QBH-Fiber Adapter



Heavy Duty Stand for 10K-W and 15K-W (Shown with a 15K-W Sensor)

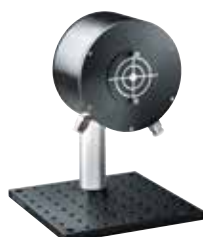

SH to BNC Adapter



N Polarity Power Supply/Charger P Polarity Power Supply/Charger Push-Pull 2 Pin Power Supply

