

### 3.3.1.5.5 13-355nm and 1.06-3000µm - Pyroelectric Array Camera

#### Pyrocam™ IIIHR & Pyrocam IV Series

##### Features

- Spectral ranges available from 13 to 355nm and 1.06 to >3000µm
- Image CO<sub>2</sub> lasers, telecom NIR lasers, THz sources and other infrared sources out to Far IR
- Solid state array camera with 1000:1 linear dynamic range for accurate profiling
- Integrated chopper for CW beams and thermal imaging
- Interchangeable windows available for a variety of applications
- Includes BeamGage® Laser Beam Analysis Software for quantitative analysis and image display



Pyrocam IIIHR



Pyrocam IIIHR Plus



Pyrocam IV

Spiricon has been the world leader in the manufacture of pyroelectric solid-state detector arrays and cameras. For over 25 years the Pyrocam has been the overwhelming camera of choice for Laser Beam Diagnostics of IR and UV lasers and high temperature thermal imaging. Precision, stability, reliability, and versatility have become its proud heritage.

The Pyrocam IIIHR offers a 1/2X1/2 inch detector array with easy Windows® camera setup and quantitative image display through the BeamGage software, 16 bit digitizer, versatile Gigabit Ethernet PC interface, and an integral chopper for CW beams and thermal imaging.

The Pyrocam IV offers a 1X1 inch detector array with easy Windows® camera setup and quantitative image display through the BeamGage software, 16 bit digitizer, with a high-speed Gigabit Ethernet PC interface, and an integral chopper for CW beams and thermal imaging.

#### See Your Beam As Never Before

Both Pyrocam cameras create clear and illuminating images of your laser beam profile. Displayed in 2D or 3D views, you can immediately recognize beam characteristics that affect laser performance and operation. This instantly alerts you to detrimental laser variations. Instantaneous feedback enables timely correction and real-time tuning of laser parameters. For example, when an industrial shop foreman saw the CO<sub>2</sub> laser beam profile in Figure 1 he knew immediately why that laser was not processing materials the same as the other shop lasers, that had similar profiles shown in Figure 2.

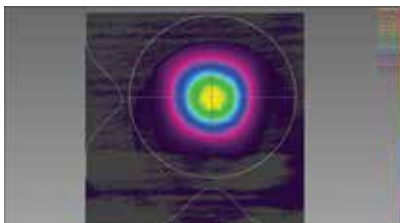

2D CO<sub>2</sub> laser beam prior to focusing optic

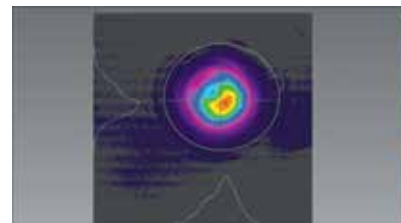

2D Same CO<sub>2</sub> laser beam at focus

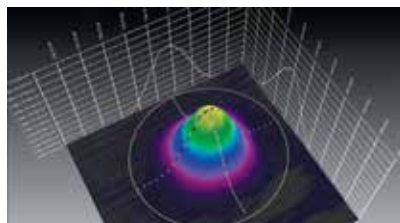

CO<sub>2</sub> laser beam prior to focusing optic

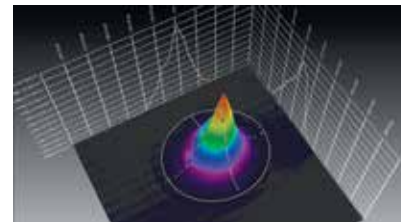

3D Same CO<sub>2</sub> laser beam at focus

## Pulsed and CW Lasers

The Pyrocams measure the beam profile of both pulsed and CW lasers. Since the pyroelectric crystal is an integrating sensor, pulses from femtosecond to 12.8ms can be measured. The pyroelectric crystal only measures changes in intensity, and so is relatively immune to ambient temperature changes. Because CW laser beams must be chopped to create a changing signal, the Pyrocam contains an integral chopper.

## Measuring Terahertz Beam Profiles

Spiricon's Pyrocam pyroelectric cameras are an excellent tool for measuring THz lasers and sources. The coating of the crystal absorbs all wavelengths including  $1\mu\text{m}$  to over  $3000\mu\text{m}$  (0.1THz to 300THz). For THz sources the sensitivity of the Pyrocam is relatively low, at about  $1.5\text{mW}/\text{cm}^2$  at full output. With a S/N of 1000, beams of  $30\text{mW}/\text{cm}^2$  are easily visible. In addition, with Spiricon's patented Ultracal baseline setting, multiple frames can be summed to "pull" a signal out of the noise. Summing 256 frames enables viewing of beams as low as  $0.5\text{--}1.0\text{mW}/\text{cm}^2$ .

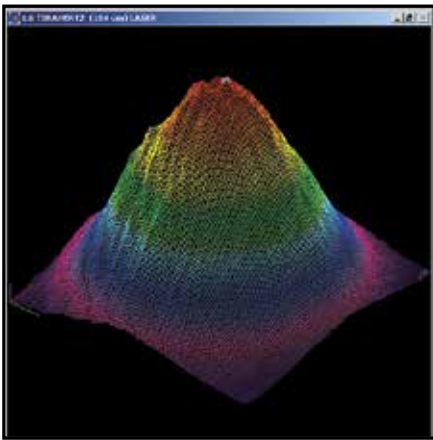

Pyrocam III imaging THz laser beam at 0.2THz (1.55mm) 3mW input power; 19 frames summed

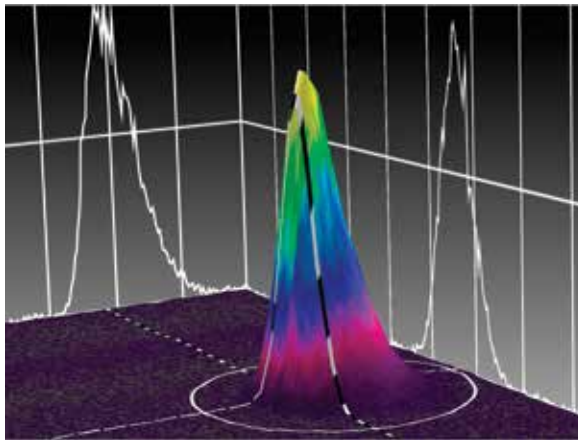

Pyrocam IV imaging THz laser beam 0.5 THz (5mm) 5mW input power; single frame

## Broad Wavelength Response

The Pyrocam detector array has a very broadband coating which enables operation at essentially all IR and UV laser wavelengths. The curve ends at 100nm in the UV, but X-ray operation has been observed. Likewise the curve ends at  $100\mu\text{m}$  in the far IR, but the camera has been used at  $>3000\mu\text{m}$ .

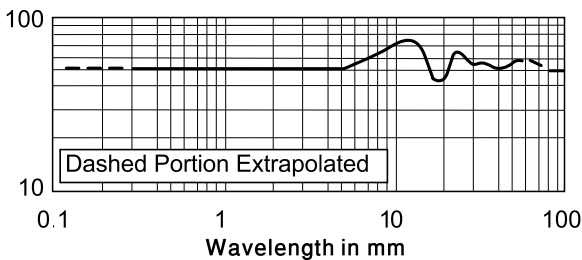
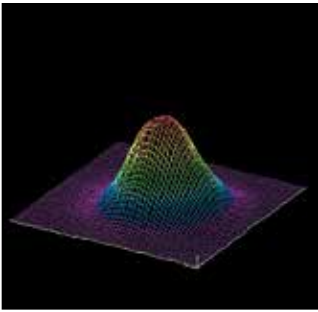
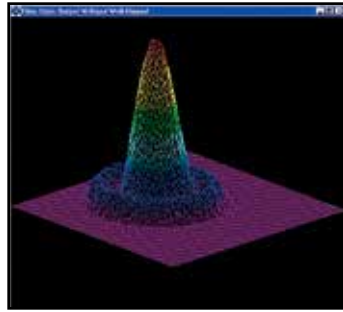

Fig. 6. Spectral response of Pyrocam™ III detector array without window.

Thus you can use the Pyrocam in the near IR for Nd:YAG lasers at  $1.06\mu\text{m}$ , and for infrared fiber optics at  $1.3\mu\text{m}$  and  $1.55\mu\text{m}$ . Use the Pyrocam for HF/DF lasers near  $4\mu\text{m}$  and for Optical Parametric Oscillators from  $1\mu\text{m}$  to  $10\mu\text{m}$ . It measures Free Electron Lasers between  $193\mu\text{m}$  and  $3000\mu\text{m}$ .



Er:YAG laser at 2.9 $\mu$ m.



Output of infrared fiber optic.

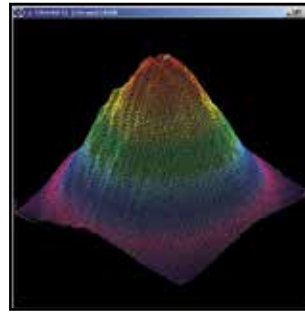

THz laser beam at 1.6THz (184 $\mu$ m).

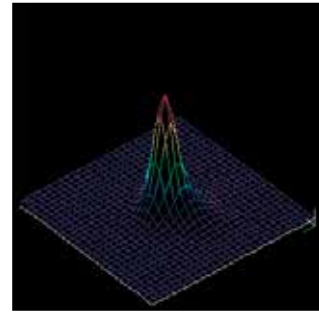

Free Electron laser at 100 $\mu$ m.

The Pyrocam is extremely useful in the UV from 13nm to 355nm for Excimer lasers and for tripled or quadrupled Nd:YAG lasers. The detector is stable under UV illumination, without the deterioration experienced by CCD cameras. (The pyroelectric detector operates in the visible spectrum, and can see the alignment HeNe used with CO<sub>2</sub> lasers. However, spurious response from the underlying silicon multiplexer creates undesirable performance, and the camera is not recommended for quantitative visible measurements).

## BeamGage Image Analysis Software

Both Pyrocam's come bundled with BeamGage, the state-of-the-art beam profiling system that performs rigorous data acquisition and analysis of laser beam parameters, such as beam size, shape, uniformity, divergence, mode content, and expected power distribution. Once the Pyrocam is connected to the PC and BeamGage is running, the software automatically detects the camera presence and is immediately ready to start taking images and displaying them on the monitor.

BeamGage is the industry's first beam profiling software to be newly designed, from scratch, using the most advanced tools and technologies. BeamGage is based on UltraCal™, Spiricon's patented baseline correction algorithm that helped establish the ISO 11146-3 standard for beam measurement accuracy. BeamGage provides high accuracy results, guaranteeing the data baseline (zero-point reference) is accurate to 1/8<sup>th</sup> of a digital count on a pixel-by-pixel basis.

BeamGage permits the user to employ custom calculations for best fit to an individual application. These user-defined computations are treated like the standard calculations. They can be displayed on the monitor, logged with results, and included in hard-copy reports. The system also allows the user to configure the displayed calculations, set-up the screen layout, and password-protect the configuration. This permits secure product testing, ensures security in production environments where plant floor personnel interface with the system, and assures the validity of the data for Statistical Process Control (SPC).

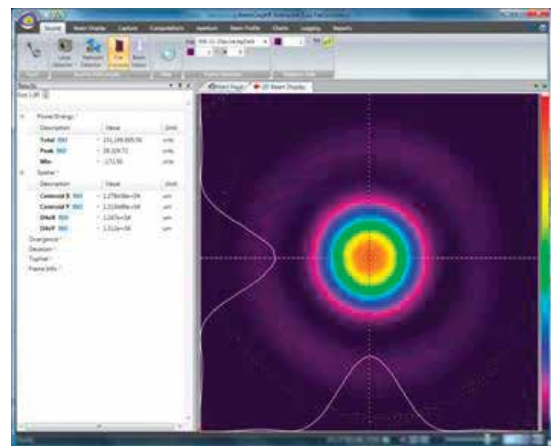

BeamGage recognizes the Pyrocam IIIHR & IV and allows you to quickly start analyzing your laser beam

## Hybrid Integrated Circuit Sensor

The Pyrocam consists of a LiTaO<sub>3</sub> pyroelectric crystal mounted with indium bumps to a solid-state readout multiplexer. This sensor, developed as the Company's core technology for the Pyrocam I, has proven to be the most rugged, stable, and precise IR detector array available. Light impinging on the pyroelectric crystal is absorbed and converted to heat, which creates charge on the surface. The multiplexer then reads out this charge. For use with short laser pulses, the firmware in the camera creates a very short electronic shutter to accurately capture the thermally generated signal.



Pyrocam™ IIIHR 12.8X12.8mm array

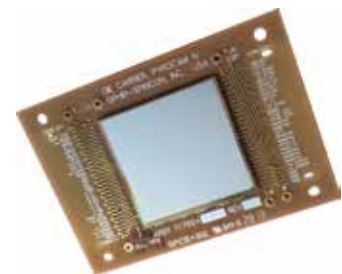

Pyrocam IV 25mm X 25mm array

## State-Of-The-Art Electronics

The camera features a high resolution A/D converter which digitizes deep into the camera noise. This enables reliable measurement and analysis of both large signals and low level signals in the wings of the laser beam. High resolution digitizing also enables accurate signal summing and averaging to pull weak signals out of noise. This is especially useful with fiber optics at 1.3 $\mu\text{m}$  and 1.55 $\mu\text{m}$ , and in thermal imaging.

## Applications Of The Pyrocam™ IIIHR

The Pyrocam is an ideal camera for use in scientific laboratory investigation of laser beams. This includes physics, chemistry, and electronic system designs. As an example, the photos below show a research CO<sub>2</sub> laser and a research Nd:YAG laser, both with cavity misalignment. The camera is also useful in product engineering of CO<sub>2</sub> and other infrared lasers. The Pyrocam is an integral part of the assembly lines of many CO<sub>2</sub> laser manufacturers. Integrators of systems are using the Pyrocam sensor to make sure that optical systems are aligned and operating properly.

There are many medical applications of the Pyrocam, such as the analysis of excimer lasers used for eye surgery. In many cases these lasers need alignment to ensure that the eye surgery is performed as expected. Other medical IR lasers perform dermatology, for which the uniformity of the beam profile must be assured.

Fiber optic communications, at 1.3 $\mu\text{m}$  and 1.55 $\mu\text{m}$  make significant use of the Pyrocam for analyzing the beams being emitted, as well as analyzing properties of the beams before launching them into fibers. The greater stability of the Pyrocam make it a good choice over other cameras operating at telecommunication wavelengths.

The Pyrocam is becoming an essential tool in the maintenance of industrial infrared lasers, especially CO<sub>2</sub>. The Pyrocam replaces non-electronic mode burns and acrylic blocks by providing higher definition electronic recording of data, and analysis of short term fluctuations. The Pyrocam is superior to other electronic methods of measuring CO<sub>2</sub> lasers because the entire beam can be measured in a single pulse, and additional measurements made in real-time. This ensures that the beam did not change during the measurement.

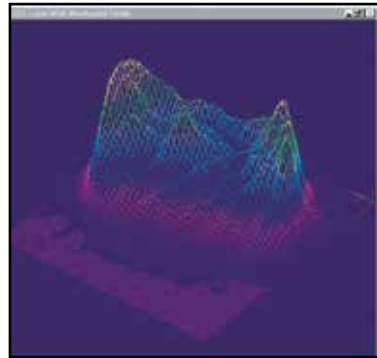

CO<sub>2</sub> laser with cavity misalignment.

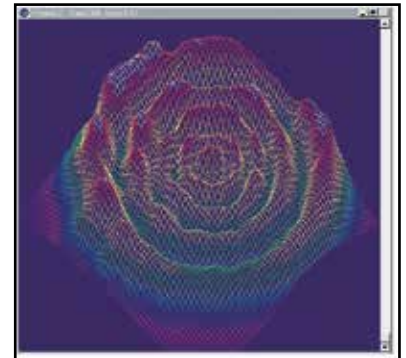

Nd:YAG laser with cavity misalignment.

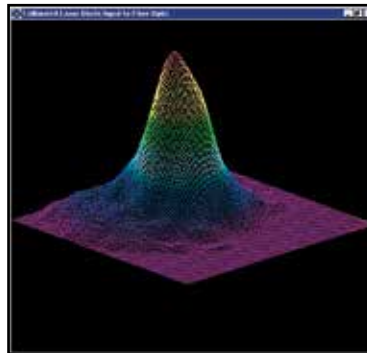

CO<sub>2</sub> laser with cavity misalignment.

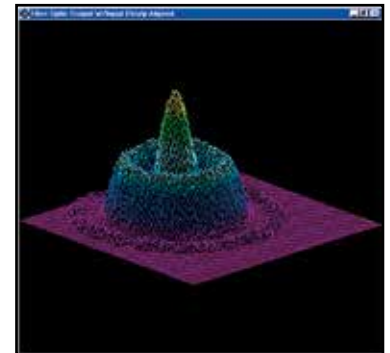

Nd:YAG laser with cavity misalignment.

## Detector Damage Threshold

The Pyrocam sensor is capable of operation with intensities about 100 times greater than CCD cameras. This makes the camera ideal for use with high power lasers, as less attenuation is required. Nevertheless, pulsed lasers with fluence too high can evaporate the absorbing front electrode.

As shown the damage threshold increases with pulse width. With nanosecond and longer pulses, detector saturation occurs before damage. With shorter pulses it helps to increase the camera amplifier gain so that electronic saturation occurs before damage.

The sensor can be damaged by excessive CW power, which causes crystal cracking. Very few Pyrocam detectors have been damaged by CW power, but some have been ablated by high peak pulse energy.

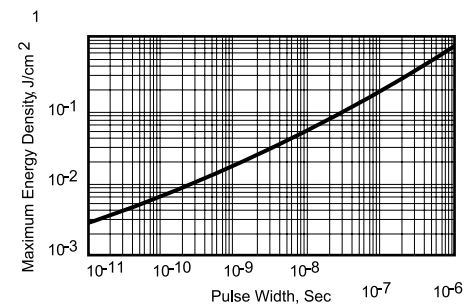

Pulsed damage threshold of pyroelectric detector coating.

Pyrocam IIIHR Dimensions

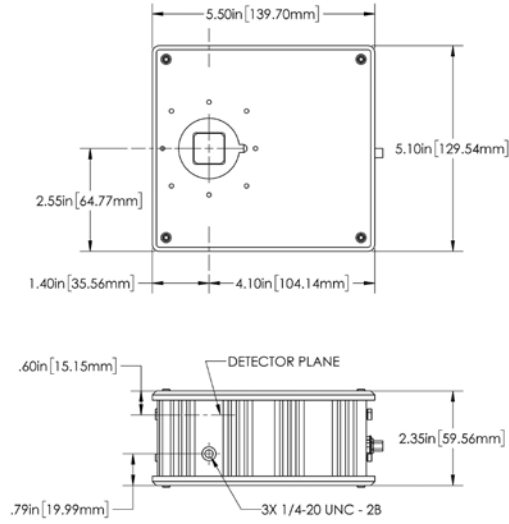

Pyrocam IIIHR Plus Dimensions

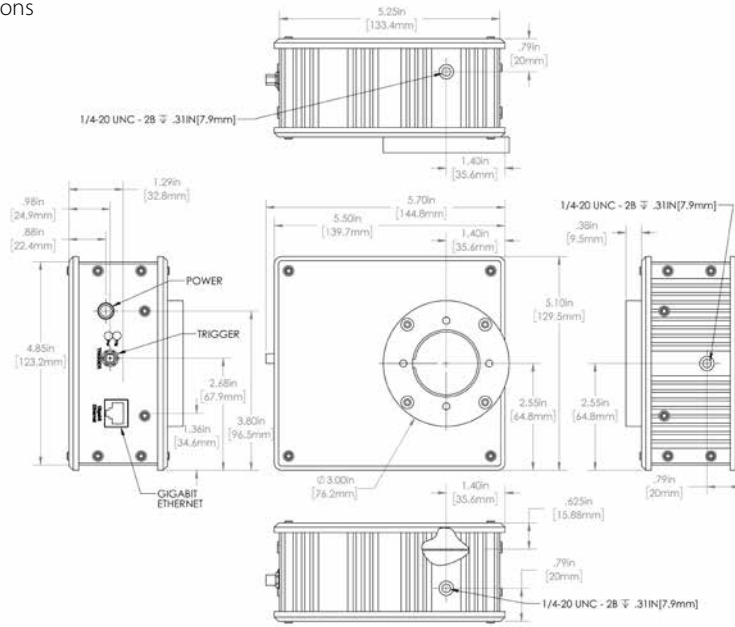

Pyrocam IV Dimensions

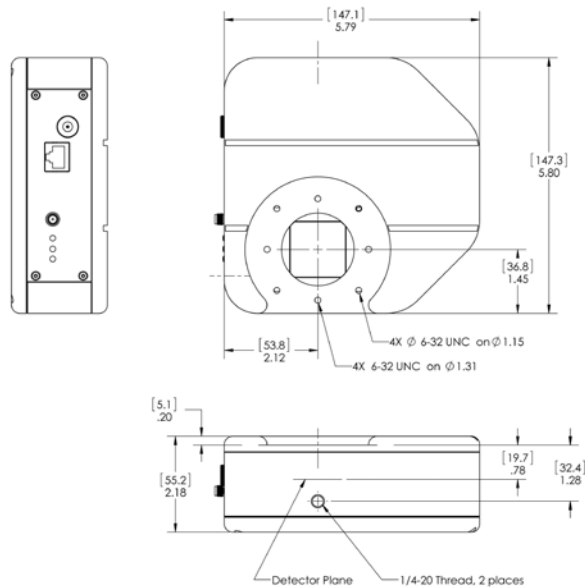



## Specifications

	Pyrocam IIIHR		Pyrocam IIIHR Plus		Pyrocam IV	
Application	UV and IR	MIR <sup>(1)</sup>	UV and IR	UV and IR	UV and IR	MIR <sup>(1)</sup>
Spectral response	13 - 355nm	3 - 5µm	13 - 355nm	13 - 355nm	13 - 355nm	3 - 5µm
Interchangeable windows	See selection in Ordering section		See selection in Ordering section		See selection in Ordering section	
Detector array details						
Active area	12.8mm x 12.8mm		12.8mm x 12.8mm		25.6mm x 25.6mm	
Element spacing	80µm x 80µm		80µm x 80µm		80µm x 80µm	
Number of elements	160 x 160		160 x 160		320 x 320	
Pixel size	75µm x 75µm		75µm x 75µm		75µm x 75µm	
<b>CHOPPED CW OPERATION</b>						
Chopping frequencies	25Hz, 50Hz		25Hz, 50Hz		25Hz, 50Hz	
Sensitivity (RMS noise limit)	64nW/pixel (25Hz)		64nW/pixel (25Hz)		64nW/pixel (25Hz)	
	96nW/pixel (50Hz)		96nW/pixel (50Hz)		96nW/pixel (50Hz)	
	1.0mW/cm <sup>2</sup> (25Hz)		1.0mW/cm <sup>2</sup> (25Hz)		1.0mW/cm <sup>2</sup> (25Hz)	
	1.5mW/cm <sup>2</sup> (50Hz)		1.5mW/cm <sup>2</sup> (50Hz)		1.5mW/cm <sup>2</sup> (50Hz)	
Noise equivalent power (NEP)	13nW/Hz <sup>1/2</sup> /pixel (1Hz)		13nW/Hz <sup>1/2</sup> /pixel (1Hz)		13nW/Hz <sup>1/2</sup> /pixel (1Hz)	
Saturation power	3.0W/cm <sup>2</sup> (25Hz)		3.0W/cm <sup>2</sup> (25Hz)		3.0W/cm <sup>2</sup> (25Hz)	
	4.5W/cm <sup>2</sup> (50Hz)		4.5W/cm <sup>2</sup> (50Hz)		4.5W/cm <sup>2</sup> (50Hz)	
Damage threshold power						
Over entire array	2W		2W		2W	
Peak Power Density	8W/CM <sup>2</sup> (Chopped mode)		8W/CM <sup>2</sup> (Chopped mode)		8W/CM <sup>2</sup> (Chopped mode)	
	4W/CM <sup>2</sup> (CW in pulsed mode)		4W/CM <sup>2</sup> (CW in pulsed mode)		4W/CM <sup>2</sup> (CW in pulsed mode)	
<b>PULSED OPERATION</b>						
Laser pulse rate	Single-shot to 1000Hz		Single-shot to 1000Hz		Single-shot to 1000Hz	
Pulse width	1fs - 12.8ms		1fs - 12.8ms		1fs - 12.8ms	
Sensitivity (peak noise limit)	0.5nJ/pixel		0.5nJ/pixel		0.5nJ/pixel	
	8µJ/cm <sup>2</sup>		8µJ/cm <sup>2</sup>		8µJ/cm <sup>2</sup>	
Saturation energy	15mJ/cm <sup>2</sup>		15mJ/cm <sup>2</sup>		15mJ/cm <sup>2</sup>	
Damage threshold	20mJ/cm <sup>2</sup> (1ns pulse)		20mJ/cm <sup>2</sup> (1ns pulse)		20mJ/cm <sup>2</sup> (1ns pulse)	
	600mJ/cm <sup>2</sup> (1 ms pulse)		600mJ/cm <sup>2</sup> (1 ms pulse)		600mJ/cm <sup>2</sup> (1 ms pulse)	
Trigger input						
High logic level	3.5 - 6.0V DC		3.5 - 6.0V DC		3.5 - 6.0V DC	
Low logic level	0 - 0.8V DC		0 - 0.8V DC		0 - 0.8V DC	
Pulse width	4µs min		4µs min		4µs min	
Trigger	Supports both trigger and strobe out		Supports both trigger and strobe out		Supports both trigger and strobe out	
Photodiode trigger	InGaAs response: SP90409		InGaAs response: SP90409		InGaAs response: SP90409	
<b>OPERATING CONNECTIONS AND CONDITIONS</b>						
Power	12VDC		12VDC		12VDC	
Line frequency	60/50Hz External Supply		60/50Hz External Supply		60/50Hz External Supply	
Power consumption	12W		12W		12W	
Operating temperature	5°C to 50°C		5°C to 50°C		5°C to 50°C	
<b>PHYSICAL</b>						
Case Dimensions	140mm H X 130mm W X 60mm D		140mm H X 130mm W X 70mm D		147.3mm H X 147.1mm W X 55.2mm D	
Detector Position	Centered in width 35.6mm from bottom		Centered in width 35.6mm from bottom		53.8mm from bottom left 36.8mm from bottom	
	15.43 ± .75mm behind front cover (without included C-mount attached) Tilt <2°		15.43 ± .75mm behind front cover (without included telescope attachment) Tilt <2°		19.7 ± .75mm behind front cover Tilt <2°	
Weight	0.85Kg (1.83lbs); not including power supply		0.85Kg (1.83lbs); not including power supply		1.2kg (2.65lbs); not including power supply	
PC interface	Gigabit Ethernet (IEEE 802.3ab), GigE Vision compliant		Gigabit Ethernet (IEEE 802.3ab), GigE Vision compliant		Gigabit Ethernet (IEEE 802.3ab), GigE Vision compliant	
<b>MEASUREMENTS PERFORMED</b>						
Comes with BeamGage PRO	Extensive set of quantitative and image display capabilities. See BeamGage data sheet.		Extensive set of quantitative and image display capabilities. See BeamGage data sheet.		Extensive set of quantitative and image display capabilities. See BeamGage data sheet.	
<b>Array Quality</b>						
	Grade A <50 bad pixels, all correctable No uncorrectable clusters		Grade A <50 bad pixels, all correctable No uncorrectable clusters		Grade A <300 bad pixels, all correctable No uncorrectable clusters	

<sup>(1)</sup> The MIR (Mid-IR) versions on the Pyrocam IIIHR and IV are designed specifically for Mid-IR lasers in the spectral range 3 to 5µm. The MIR versions feature specifically designed sensors that maximize the optical signal for high fidelity spatial profile measurements of laser beam in the 3 to 5µm spectral range.

## Ordering Information

Item	Description	P/N
13 - 355nm & 1.06 - 3000µm BeamGage <b>Professional</b>	a windowless bezel comes with the unit, other windows available for purchase	
PY-III-HR-C-A-PRO	Pyroelectric array detector, chopped, Grade A, one Gigabit Ethernet port, BeamGage Professional, GigE to USB3 adaptor, hard shipping case, 3 meter GigE cable, and power supply w/locking connector included.	SP90405
PY-III-HR-C-MIR-PRO	Pyroelectric array detector, chopped, Grade A, one Gigabit Ethernet port, BeamGage Professional, GigE to USB3 adaptor, hard shipping case, 3 meter GigE cable, and power supply w/locking connector included.	SP90415
PY-III-HR-C-A-PLUS	Pyroelectric array detector, chopped, Grade A, one Gigabit Ethernet port, BeamGage Professional, GigE to USB3 adaptor, hard shipping case, 3 meter GigE cable, and power supply w/locking connector included. Comes with telescopic adaptor mounted to front case.	SP90448
<b>Optional windows for Pyrocam IIIHR</b>		
PY-III-HR-W-BK7-1.064	Pyrocam III-HR window assembly, BK7, A/R coated for 1.064µm	SP90365
PY-III-HR-W-SI-1.05-2.5	Pyrocam III-HR window assembly, Si, A/R coated for 1.05 to 2.5µm	SP90366
PY-III-HR-W-SI-2.5-4	Pyrocam III-HR window assembly, Si, A/R coated for 2.5 to 4µm	SP90367
PY-III-HR-W-GE-3-5.5	Pyrocam III-HR window assembly, Ge, A/R coated for 3 to 5.5µm	SP90368
PY-III-HR-W-GE-10.6	Pyrocam III-HR window assembly, Ge, A/R coated for 10.6µm	SP90369
PY-III-HR-W-GE-8-12	Pyrocam III-HR window assembly, Ge, A/R coated for 8 to 12µm	SP90370
PY-III-HR-W-ZNSE-10.6	Pyrocam III-HR window assembly, ZnSe, A/R coated for 10.6µm	SP90371
PY-III-HR-W-ZNSE-10.2µm & 10.6µm	Pyrocam III-HR window assembly, ZnSe, A/R coated for 10.2µm & 10.6µm	SP90412
PY-III-HR-W-ZNSE-2-5	Pyrocam III-HR window assembly, ZnSe, A/R coated for 2 to 5µm	SP90372
PY-III-HR-W-BaF2-Uncoated	Pyrocam III-HR window assembly, BaF2 uncoated for 193 to 10µm	SP90373
PY-III-HR-W-POLY-THZ	Pyrocam III-HR window assembly, LDPE, uncoated for Terahertz wavelengths	SP90374
PY-IV-C-A-PRO	Pyroelectric array detector, chopped, Grade A, one Gigabit Ethernet port, BeamGage Professional, GigE to USB3 adaptor, hard shipping case, 3 meter GigE cable, and power supply w/locking connector included.	SP90404
PY-IV-C-MIR-PRO	Pyroelectric array detector, chopped, Grade A, one Gigabit Ethernet port, BeamGage Professional, GigE to USB3 adaptor, hard shipping case, 3 meter GigE cable, and power supply w/locking connector included.	SP90414
<b>Optional windows for Pyrocam IV</b>		
PY-IV-W-BK7-1.064	Pyrocam IV window assembly, BK7, A/R coated for 1.064µm	SP90301
PY-IV-W-SI-1.05-2.5	Pyrocam IV window assembly, Si, A/R coated for 1.05 to 2.5µm	SP90302
PY-IV-W-SI-2.5-4	Pyrocam IV window assembly, Si, A/R coated for 2.5 to 4µm	SP90303
PY-IV-W-GE-3-5.5	Pyrocam IV window assembly, Ge, A/R coated for 3 to 5.5µm	SP90304
PY-IV-W-GE-10.6	Pyrocam IV window assembly, Ge, A/R coated for 10.6µm	SP90305
PY-IV-W-GE-8-12	Pyrocam IV window assembly, Ge, A/R coated for 8 to 12µm	SP90306
PY-IV-W-ZNSE-10.6	Pyrocam IV window assembly, ZnSe, A/R coated for 10.6µm	SP90307
PY-IV-W-ZNSE-2-5	Pyrocam IV window assembly, ZnSe, A/R coated for 2 to 5µm	SP90308
PY-IV-W-ZNSE-UNCOATED	Pyrocam IV window assembly, ZnSe, uncoated	SP90336
PY-IV-W-POLY-THZ	Pyrocam IV window assembly, LDPE, uncoated for Terahertz wavelengths	SP90309
<b>Options</b>		
BSQ-PY-M	Pyrocam license for Manual BeamSquared	SP90410