

1.1.2.4 Low - Medium Power Thermal Sensors - Apertures to 26mm

1.1.2.4.1 Medium Power BeamTrack-Power / Position / Size Sensors

40mW to 150W

Features (see introduction in pages 109-111)

- All the features of standard power sensors plus...
- Accurate tracking of beam position to fractions of a mm
- Monitoring of the laser beam size

50(150)A-BB-26-QUAD
/ 50(150)A-BB-26-PPS



F150A-BB-26-PPS



Model	50(150)A-BB-26-QUAD ^(a)	50(150)A-BB-26-PPS ^(a)	F150A-BB-26-PPS ^(a)
Use	General purpose	General purpose	General purpose
Functions	Power / Energy / Position	Power / Energy / Position / Size	Power / Energy / Position / Size
Absorber Type	Broadband	Broadband	Broadband
Spectral Range μm	0.19 - 11	0.19 - 11	0.19 - 11
Aperture mm	\varnothing 26mm	\varnothing 26mm	\varnothing 26mm
Power Mode			
Power Range	40mW - 150W	40mW - 150W	50mW - 150W ^(b)
Maximum Intermittent Power	150W for 1.5min, 100W for 2.2min, 50W continuous	150W for 1.5min, 100W for 2.2min, 50W continuous	N.A.
Power Scales	150W / 50W / 5W	150W / 50W / 5W	150W / 30W / 3W
Power Noise Level	2mW	2mW	8mW ^(b)
Maximum Average Power Density kW/cm ²	12 at 150W, 17 at 50W	12 at 150W, 17 at 50W	12 at 150W, 17 at 50W
Response Time with Meter (0-95%) typ. s	1.5	1.5	1.5
Calibration Uncertainty $\pm\%$	1.9	1.9	1.9
Power Accuracy $\pm\%$	3 ^(f)	3 ^(f)	3 ^(f)
Linearity with Power $\pm\%$	1.5	1.5	1
Energy Mode			
Energy Range	20mJ - 100J	20mJ - 100J	20mJ - 100J
Energy Scales	100J / 30J / 3J / 300mJ	100J / 30J / 3J / 300mJ	100J / 30J / 3J / 300mJ
Minimum Energy mJ	20	20	20 ^(b)
Maximum Energy Density J/cm ²			
<100ns	0.3	0.3	0.3
0.5ms	5	5	5
2ms	10	10	10
10ms	30	30	30
Beam Tracking Mode			
Position			
Beam Position Accuracy mm ^(c)	0.1 + 5% of distance from center	0.1 + 5% of distance from center	0.1 + 5% of distance from center
Beam Position Resolution mm	0.1	0.1	0.1
Min Power for Position Measurement	1W	1W	1W
Size ^(d)			
Size Accuracy mm ^(e)	N.A.	\pm 5% for centered beam	\pm 5% for centered beam
Size Range mm (4 σ beam diameter)	N.A.	\varnothing 3 - 20	\varnothing 3 - 20
Min Power Density for Size Measurement	N.A.	1 W/cm ²	1 W/cm ²
Cooling	Convection	Convection	Fan
Fiber Adapter Available (see page 118)	ST, FC, SMA, SC	ST, FC, SMA, SC	ST, FC, SMA, SC
Weight Kg	0.4	0.4	0.45
Compliance	CE, UKCA, China RoHS	CE, UKCA, China RoHS	CE, UKCA, China RoHS
Version	V1	V1	V1
Part number	7Z07938	7Z07907	7Z07906

Note: (a) The BeamTrack features are supported by Centauri, StarBright, StarLite, Nova II and Vega meters, Juno, Juno+, Juno-RS and EA-1 interfaces and StarLab application. Position and Size measurements work only in Power mode (but not in single shot Energy mode).

Note: (b) For powers up to 30W it is recommended to work with the fan off and then the noise level is ~3 times lower. It is also recommended to measure energy with the fan off.

Note: (c) Position accuracy for the central 10mm of the aperture as limited by beam position resolution. Position can be tracked with \pm 1mm accuracy over the entire aperture. Accuracy is reduced by a factor of 3 at minimum power. Position measuring center corresponds to geometrical center within <1mm. Position center can be software reset to geometric center or other desired position with Centauri, StarBright or StarLab.

Note: (d) Assumes laser beam with Gaussian (TEM₀₀) distribution. For other modes, size measurement is relative.

Note: (e) Accuracy spec will be maintained for beams from 3.5 to 17mm not deviating from center more than 15% of beam diameter. For beams below 8mm in size and powers above 75W error in size can reach \pm 10%.

Note: (f) \pm 4%. For wavelengths <240nm

* For drawings please see page 63

Interface Module on cable

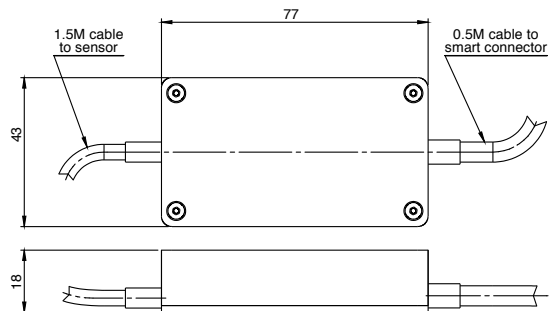

50(150)A-BB-26-QUAD / 50(150)A-BB-26-PPS

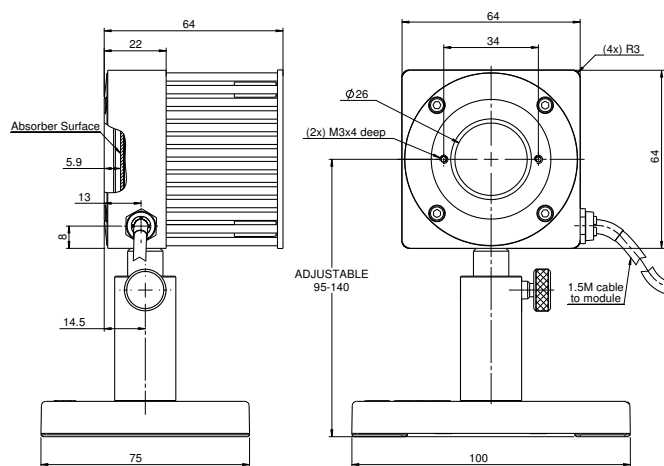

F150A-BB-26-PPS

