

1.1.2.3 Low Power Thermal Sensors

40mW to 50W

Features

- Convection air cooled
- P, PF and N type absorbers for short pulses
- Ø16mm to 17.5mm apertures



Model	10A-P	30A-P-17	15(50)A-PF-DIF-18/ 50A-PF-DIF-18	30A-N-18
Use	Short pulse to 10W	Short pulse to 30W	High energy density pulsed beams	High power density pulsed YAG
Absorber Type	P type	P type	PF type + diffuser	N type
Spectral Range μm	0.15 - 8	0.15 - 8	0.24 - 2.2	0.532, 1.064
Aperture mm	Ø16mm	Ø17mm	Ø17.5mm	Ø17.5mm
Power Mode				
Power Range	40mW - 10W	60mW - 30W	140mW - 50W	60mW - 30W
Maximum Intermittent Power W	N.A.	N.A.	(for 15(50)A-PF-DIF-18 only) 50W for 5min, 15W continuous	N.A.
Power Scales	10W / 2W / 200mW and dBm	30W / 3W	50W / 5W	30W / 3W
Power Noise Level	2mW	3mW	7mW	3mW
Maximum Average Power Density kW/cm ²	0.05	0.05	>10	5
Response Time with Meter (0-95%) typ. s	3.5	2.5	2	2
Calibration Uncertainty $\pm\%$	1.9	1.9	1.9	1.9
Power Accuracy $\pm\%$	3	3	5	3
Linearity with Power $\pm\%$	1.5	1.5	1.5	1
Energy Mode				
Energy Range	10mJ - 10J	40mJ - 30J	60mJ - 200J	30mJ - 200J
Energy Scales	10J / 2J / 200mJ	30J / 3J	200J / 30J / 3J	200J / 30J / 3J
Minimum Energy mJ	10	40	60	30
Maximum Energy Density J/cm ² (a)				
Pulse rate:	Single 10 - 30Hz	Single 10 - 30Hz	10 - 50Hz	10 - 50Hz
<1 μs	10 1	10 1	4	1
0.5ms	10 1	10 1	15	20
5ms	10 1	10 1	50	>100
Cooling	convection	convection	convection	convection
Fiber Adapters Available (see page 118)	ST, FC, SMA, SC	ST, FC, SMA, SC	NA	ST, FC, SMA, SC
Weight kg	0.2	0.3	0.35	0.3
Compliance	CE, UKCA, China RoHS	CE, UKCA, China RoHS	CE, UKCA, China RoHS	CE, UKCA, China RoHS
Version	V3			
Part number	7Z02649	7Z02693	7Z02740/ 7Z02738	7Z02695
Note: (a) For shorter wavelengths derate maximum energy density as follows:	Wavelength 1064nm 532nm 355nm 266nm 193nm	Derate to value Not derated Not derated 40% of stated value 10% of stated value 10% of stated value	Wavelength 1064nm 532nm 355nm 266nm 193nm	Derate to value Not derated 80% of stated value 60% of stated value 40% of stated value N.A.

* For drawings please see page 54

10A-P

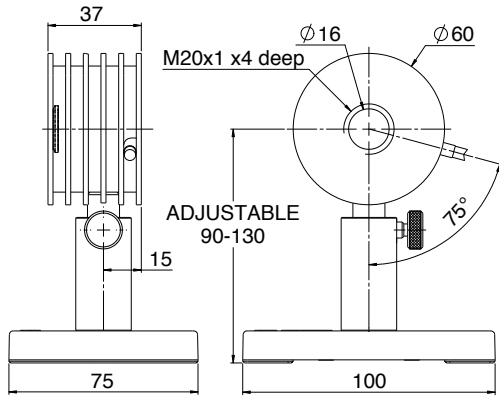

30A-P-17

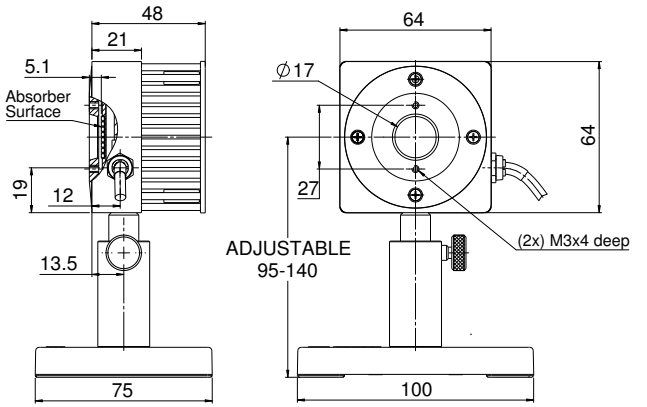

15(50)A-PF-DIF-18

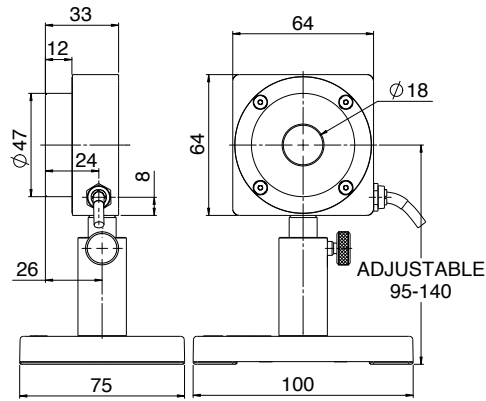

50A-PF-DIF-18

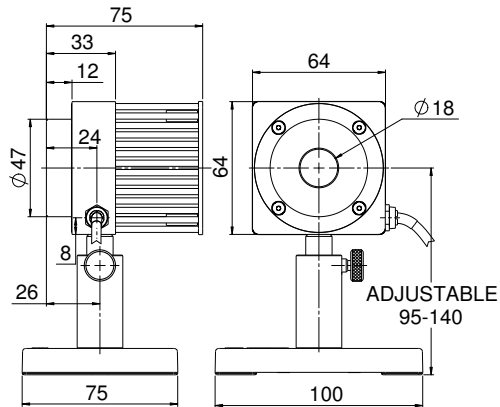

30A-N-18

